

Instructions for use



YOUNG[™]
INFINITY

CORDLESS HYGIENE HANDPIECE



This page left intentionally blank.

Contents

Symbols.....	4 – 7
1. Introduction.....	8 – 9
2. Electromagnetic compatibility (EMC)	10
3. Package Contents	11
4. Safety notes.....	12 – 16
5. Description of handpiece.....	18
6. Description of foot control.....	19
7. Description status LED – Handpiece	20
8. Description status LED – Foot control.....	21
9. Start-up – Charging the battery	22
10. Start-up – Query battery status	23
11. Start-up – Pairing.....	24 – 25
12. Start-up – Attachment & removal of disposable barrier sleeve and doriot style disposable prophylaxis angle	26 – 27
13. Operation – Handpiece	28
14. Test run.....	29
15. Hygiene and maintenance	30 – 34
16. Replacing the O-ring.....	35
17. Young Dental accessories and spare parts	36
18. Servicing.....	37 – 38
19. Technical data	39 – 40
20. Disposal.....	41
Explanation of warranty terms.....	42
Authorized Young Dental service partners	43

Symbols in the instructions for use



WARNING!
[risk of injury]



ATTENTION!
[to prevent damage occurring]



General explanations,
without risk to persons or property



Thermo washer disinfectable



Sterilizable
up to the stated temperature



Not for re-use



Call customer service

Symbols on the handpiece



Follow instructions for use



Article number



Date of manufacture



Serial number



Do not dispose of with domestic waste



Non-sterilizable



Data Matrix code for product information including UDI (Unique Device Identification)



Non-ionizing electromagnetic radiation



Not suitable for intracardiac application – Type BF appliance



The medical device with reference to electrical safety, mechanical safety and fire prevention conforms to UL 60601-1:2006, CAN/CSA-C22.2 No.601.1-M90:2005, CAN/CSA-C22.2 No. 60601-1:2008, ANSI/AAMI ES 60601-1:2005 25UX (Control No.)

Symbols on the foot control



Do not dispose of with domestic waste



Non-ionizing electromagnetic radiation



DC – direct current



Data Matrix code for product information including UDI (Unique Device Identification)



Article number



Protection against dripping water



UL Component Recognition Mark indicates compliance with Canadian and U.S. requirements



Serial number



Foot control cordless C-NW



Date of manufacture



Reset

Symbols on the packaging



This way up



Fragile, handle with care



Keep dry



»Der Grüne Punkt«
(The Green Dot) trademark of Duales
System Deutschland GmbH



Identification of recyclable
transport and outer packaging
of paper and cardboard



Data Matrix code
for product information including UDI
(Unique Device Identification)

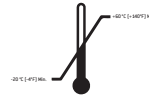

Permitted temperature range



Humidity,
limitation



Caution! According to U.S. federal
law, this medical device may only be
sold by or on the order of a dentist,
physician or any other medical
practitioner licensed by the law of
the state in which he or she practices
and who intends to use or order the
use of this medical device.

1. Introduction



For your safety and the safety of your patients

These instructions provide recommendations for safe operation of the enclosed medical device and are intended to protect the safety of the operator and patient.



Observe the safety notes on pages 12 to 16.

Intended use and Operational Contexts of Use

Handpiece: Battery driven electrical drive unit with wireless foot controller to perform cleaning and polishing of tooth surfaces and fillings.

Foot controller: Foot control for operation of medical electrical equipment.



Misuse may damage the medical device and subsequently cause risks and hazards for patients, users and third parties.

The cordless handpiece was designed for use by dentists, dental hygienists, dental employees (prophylaxis), and dental assistants.

Introduction



Responsibility of the manufacturer

The manufacturer can only accept responsibility for the safety, reliability and performance of the medical device if it is used in compliance with the following directions:

- > The medical device must be used in accordance with these instructions for use.
- > The medical device does not have any components that can be repaired by the user. Assembly, modifications or repairs must only be undertaken by an authorized Young Dental service partner (see page 43).
- > The electrical installation at the premises must comply with the regulations laid out in IEC 60364-7-710 (>Installation of electrical equipment in rooms used for medical purposes«) or with the regulations applicable in your country.
- > Unauthorized opening of the medical device invalidates all claims under warranty and any other claims.

2. Electromagnetic compatibility (EMC)



Medical electrical equipment is subject to particular precautions with regard to EMC and must be installed and put into operation in accordance with the EMC notes included.

Young Dental only guarantees compliance of the control unit with the EMC Directives when it is used with original Young Dental accessories and spare parts. The use of accessories and spare parts that have not been approved by Young Dental may lead to increased emission of electromagnetic interference or to reduced resistance to electromagnetic interference.



You may find current EMC manufacturer declarations at www.youngdental.com



HF communication equipment

Do not use any portable and mobile HF communication equipment (e.g., mobile telephones) during operation. These may affect medical electrical equipment.

3. Package Contents

REF	Description
295721	White Handpiece
295792	Foot Controller incl. Stick
295788	Charger incl. adaptor
295789	Handpiece cradle
295830	Disposable Barrier Sleeve (1 pack of 25 sleeves)
295791	Removable nosecone (3 units - 1 on handpiece and 2 in the box)

4. Safety notes

- 
- > When operating the handpiece, always consider the safety of the patient.
 - > Before using the medical device for the first time, store it at room temperature for 24 hours.
 - > Check the medical device for damage and loose parts before every use.
 - > Do not operate the medical device if it is damaged.
 - > Replace the foot control as soon as the resistance of the pedal is noticeably reduced.
 - > Always ensure that the correct operating conditions are provided.
 - > Perform a test run outside the patient's oral cavity prior to every treatment. If any abnormalities are found, stop using immediately and contact Young Dental. Abnormalities can include, but are not limited to, vibration, noise, and overheating.
 - > Always operate the handpiece with fitted nosecone.
 - > Follow additional manufacturer safety recommendations for the doriot style disposable prophylaxis angle.
 - > Never touch the patient and the electrical contacts on the medical device simultaneously.
 - > Keep the foot control away from magnetic fields.
 - > Should the handpiece function abnormally during use, cease operation immediately and return the handpiece to an authorized Young Dental service partner for repair [see page 43].

- 
- Battery**
- > Charge the battery of the handpiece and the foot control as soon as the status LED flashes.
 - > Do not leave the battery to charge unattended.
 - > The battery used can pose a risk of fire or chemical burns if it is not used correctly.
 - > Send the handpiece or foot control to an authorized Young Dental service partner [see page 43] for replacement of the battery as soon as the charging cycles start to deteriorate.
 - > Defective or worn-out batteries must only be replaced by an authorized Young Dental service partner [see page 43].

Safety notes

 The medical device is classed as »conventional equipment« (closed equipment without protection against the ingress of water).

 **Charger**
> Only use the charger supplied.

System failure

A total system failure does not constitute a critical fault.

Simply switch the unit off and then on again.

 **Hygiene and maintenance prior to initial use**
> Clean and reprocess the handpiece and the foot control.
> Sterilize the handpiece nosecone.

 **Improper use**
In addition to unauthorized assembly or modification of or repairs to the medical device and non-compliance with our instructions, improper use will invalidate all claims made under warranty or otherwise.

Safety notes



Danger zones M and G

The medical device is not suitable for use in potentially explosive atmospheres or with potentially explosive mixtures of anaesthetic substances containing oxygen or nitrous oxide according to IEC 60601-1/ANSI/AAMI ES 60601-1.



The medical device is not suitable for use in oxygen-enriched atmospheres.



Zone M is defined as a »medical environment« and constitutes the part of a room in which potentially explosive atmospheres may form due to the use of anaesthetics or medical antiseptics and antibacterial soaps; such atmospheres are typically localized and temporary.

Zone M comprises a truncated pyramid below the operating table which is tilted outwards at a 30° angle.



Zone G, also known as an »enclosed medical gas system«, does not necessarily include areas enclosed around all sides, in which explosive mixtures are continuously or temporarily generated, directed or used in small quantities.

Safety notes



Risks due to electromagnetic fields

The functionality of implantable systems, such as cardiac pacemakers and implantable cardioverter defibrillators (ICD) can be affected by electric, magnetic and electromagnetic fields.

- > Find out if patients and users have an implanted device before using the medical device and test the possible applications.
- > Weigh the risks and benefits.
- > Keep the medical device away from implanted devices.
- > Take appropriate emergency precautions and take immediate action on any signs of changes to health.
- > Symptoms such as increased heartbeat, irregular pulse and dizziness can be signs of a problem with a cardiac pacemaker or ICD.

Safety notes

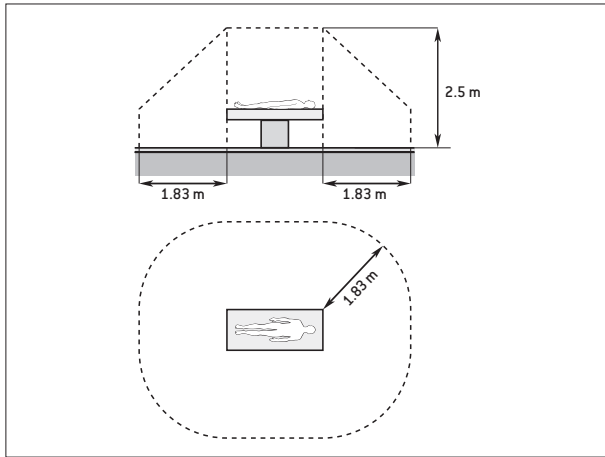

The patient environment (see diagram) encompasses the area up to 2.50 m above the patient and 1.83 m in all horizontal directions.



The charger must not be used within the patient environment.

This page left intentionally blank.

5. Description of handpiece

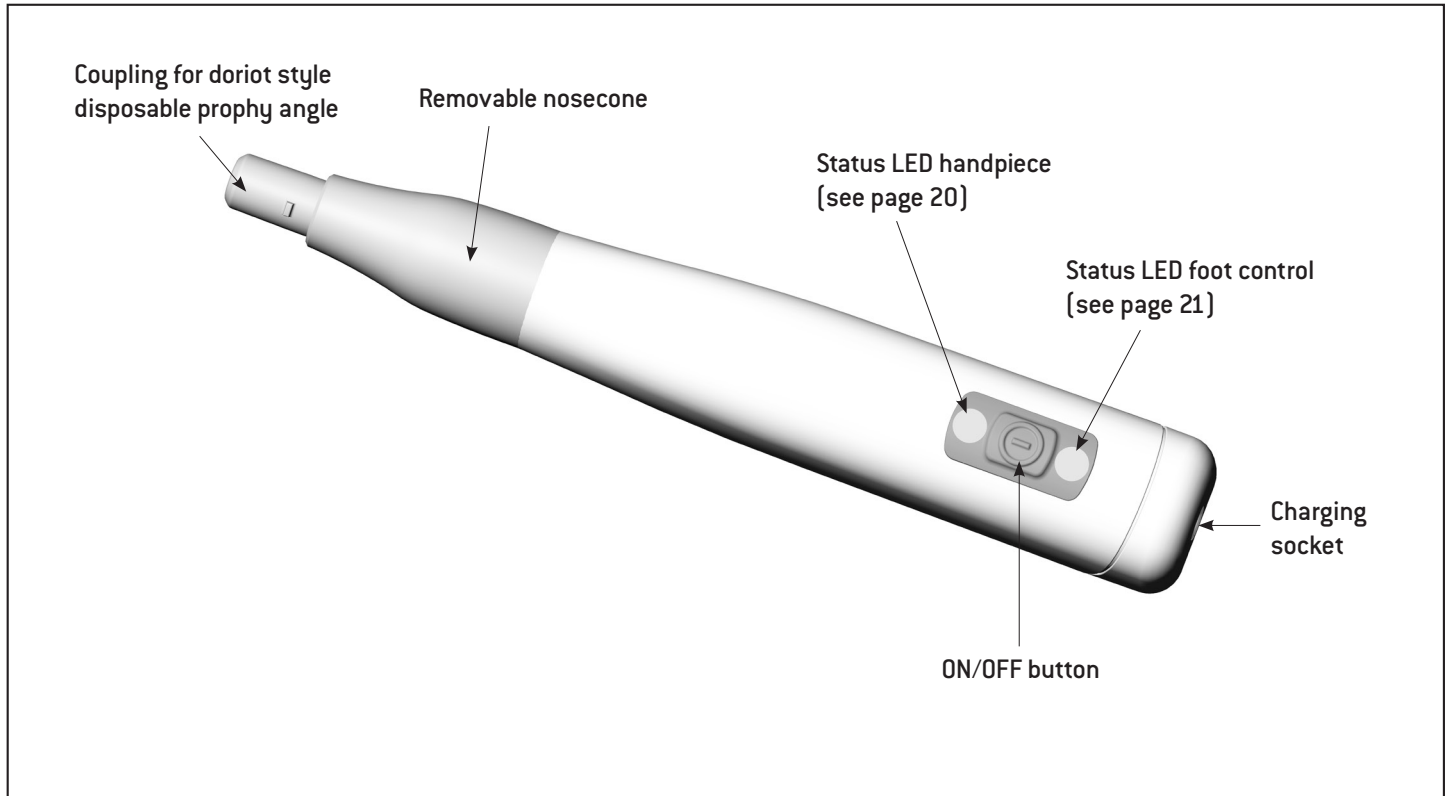

6. Description of foot control

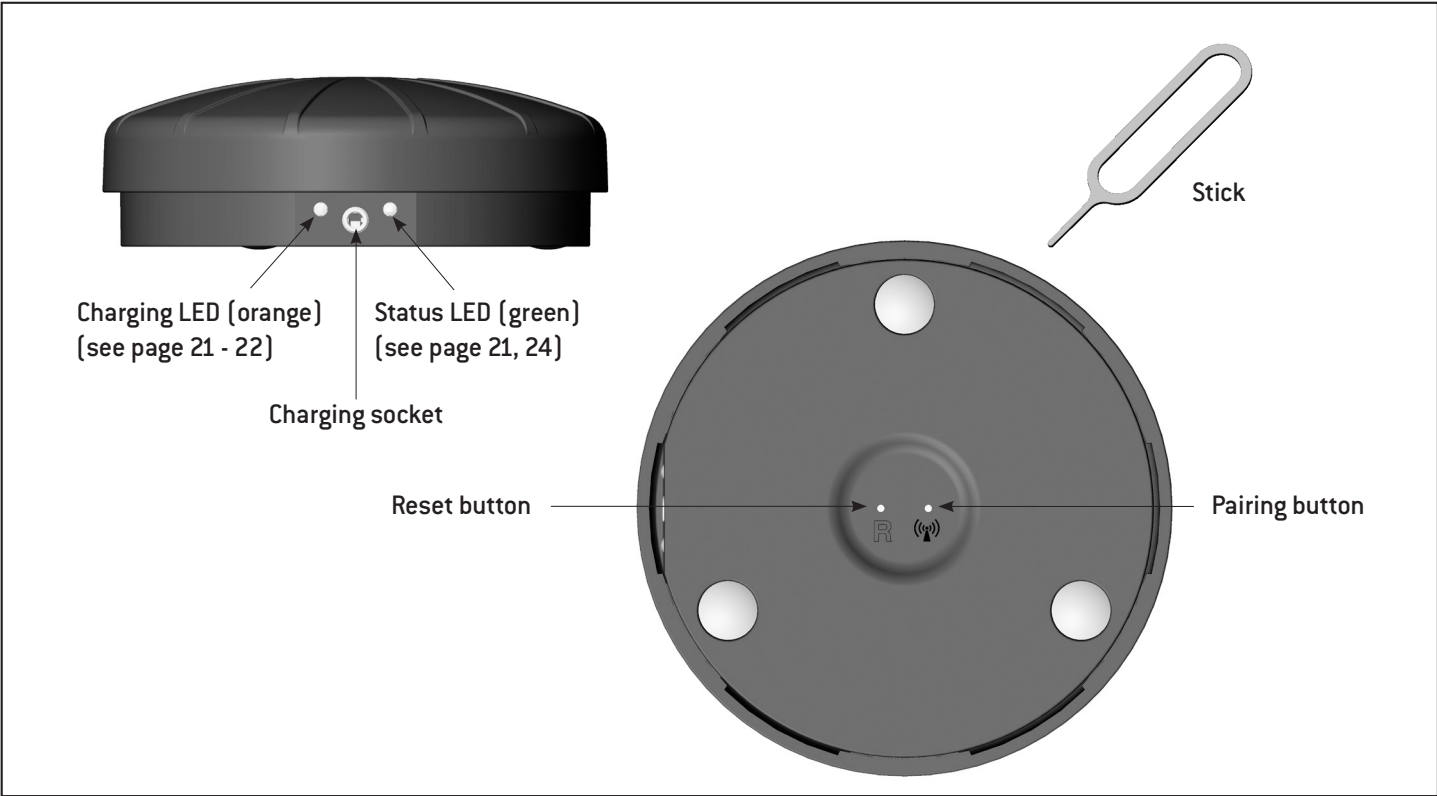

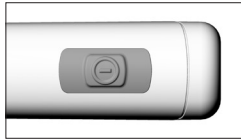

7. Description status LED – Handpiece





Standby mode

- > The handpiece can be activated with the ON/OFF button.
- > If the handpiece is not used for longer than 4 minutes, it returns to standby mode automatically.

LED	illuminates	flashes	flashes intermittently
			
GREEN	<ul style="list-style-type: none"> → Battery is 25 – 100% charged → Pairing successful > Handpiece is ready for operation 	<ul style="list-style-type: none"> → Pairing active 	
ORANGE	<ul style="list-style-type: none"> → Battery is charging 	<ul style="list-style-type: none"> → Battery is 2 – 25% charged > Complete the treatment > Do not start any further treatment > Charge the battery 	<ul style="list-style-type: none"> → Battery is 1% charged > Charge the battery
RED		<ul style="list-style-type: none"> → Error message > Contact a Young Dental service partner 	





8. Description status LED – Foot control

LED	flashes	flashes alternately
		
ORANGE	<ul style="list-style-type: none"> → Battery of foot control is dead > Complete the treatment > Charge the battery of the foot control 	<ul style="list-style-type: none"> → Pairing unsuccessful > Troubleshooting with pairing problems (see page 25)



Standby mode

- > The foot control can be activated by pressing.

LED	illuminates	illuminates	flashes	flashes intermittently*
				
GREEN	<ul style="list-style-type: none"> → Connection to paired device established 		<ul style="list-style-type: none"> → Foot control is attempting to establish a connection to the paired device 	<ul style="list-style-type: none"> → Battery is dead > Charge the battery
ORANGE		<ul style="list-style-type: none"> → Battery is charging 		

* The LED flashes for 40 milliseconds every 4 seconds

9. Start-up – Charging the battery

 Important! Fully charge the handpiece and foot control before initial use.

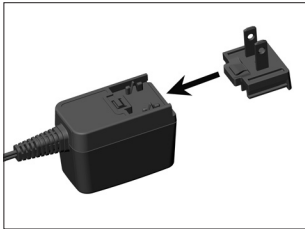

- ❶ Attach the correct plug to the charger power cord.

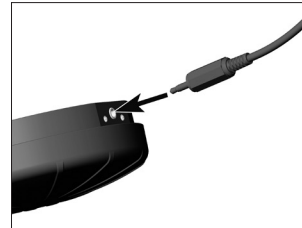

- ❸ After the battery of the handpiece is fully charged connect the charger into the foot control charging socket.

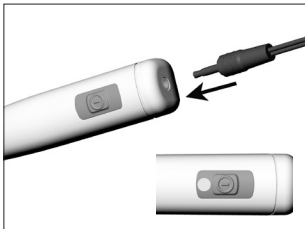

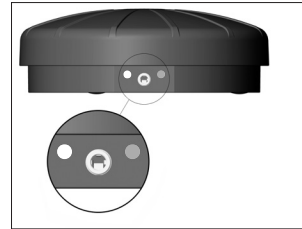

- ❷ Connect the charger up to the charging socket on the handpiece.

 LED orange:
Battery is charging.
LED green:
Battery is charged.



- ❹ LED orange: Battery is charging.

 LED off: Battery is charged.

 The handpiece will not switch to standby mode as long as it is plugged into the charger.

10. Start-up – Query battery status

 You can query the battery status when the handpiece is switched on and during the charging process.

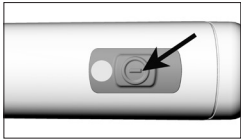

> Briefly press the ON/OFF button:

LED	flashes	Battery status
		
	3 x green	75 – 100 %
	2 x green	50 – 75 %
	1 x green	25 – 50 %
	orange	2 – 25 %

11. Start-up – Pairing

 For your convenience, the handpiece and foot control have been paired. To verify that pairing has been activated, look for an illuminated green LED light on the foot control.

If the green light is not on, please follow the steps below to pair the devices. Note: Both devices must be within the same vicinity and placed into pairing mode.

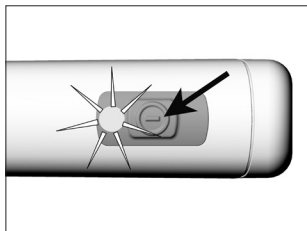

-  **1** Press the ON/OFF button on the handpiece for approximately 5 seconds to activate pairing mode.
LED flashing green: The handpiece will remain in pairing mode for 30 seconds.

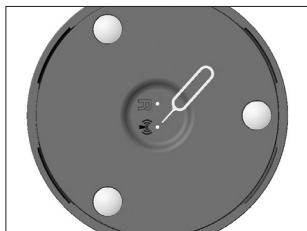

- 2** Use the stick to press the pairing button on the bottom of foot control and hold for 3 seconds to activate the foot control pairing mode.



The stick is intended to be used on uncontaminated devices only. If the stick becomes contaminated, discard the stick and order a replacement part.

Start-up – Pairing

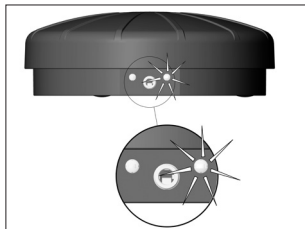

- ③ The foot control will remain in pairing mode for 30 seconds - indicated when the green LED light changes from flickering to flashing.

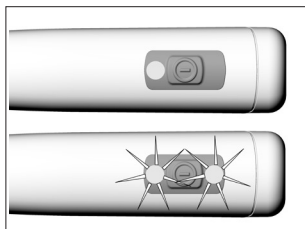

- ④ Pairing successful.



LED green.

Pairing unsuccessful.



LED flashing alternately orange. The LED goes out after 10 seconds.

Troubleshooting with pairing problems

- > Remove any metallic objects located between the foot control and handpiece.
- > Change the position of the foot control.
- > Eliminate any sources of interference (e.g. brush motors, mobile telephones, radios, WLAN, ...)
- > Use the stick to press the reset button on the foot control and try pairing again.



If the pairing problem cannot be remedied using the steps described above, the unit will need to be inspected by an authorized Young Dental service partner [see page 43].

12. Start-up – Attachment & removal of disposable barrier sleeve and doriot style disposable prophylactic angle

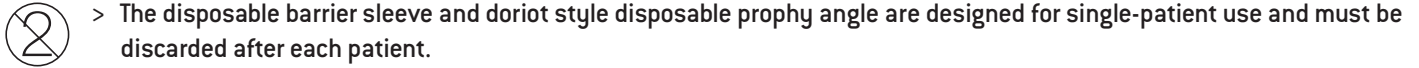

- > The disposable barrier sleeve and doriot style disposable prophylactic angle are designed for single-patient use and must be discarded after each patient.

Disposable barrier sleeve and doriot style disposable prophylactic angles are not autoclavable or designed to withstand reprocessing agents.



- > Only use doriot style disposable prophylactic angles in perfect condition and observe the manufacturer's operating instructions.
- > Only attach or remove a disposable barrier sleeve and a doriot style disposable prophylactic angle when the handpiece is stationary and turned off.
- > Never touch a doriot style disposable prophylactic angle that is still rotating.



- > Only use doriot style disposable prophylactic angles.
- > Do not operate handpiece with reusable prophylactic angles that have metal shafts. Reusable prophylactic angles with metal shafts damage the automatic clamping chuck system.

Start-up – Attachment & removal of disposable barrier sleeve and doriot style disposable prophylaxis angle

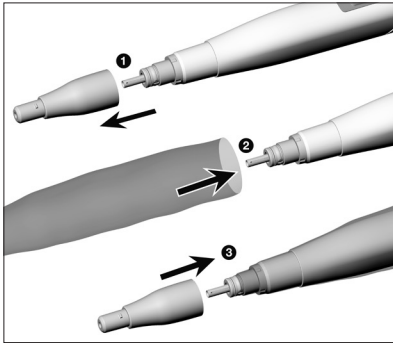

- 1 Remove handpiece nosecone.
- 2 Place disposable barrier sleeve over the internal shoulder of the handpiece.
- 3 Place handpiece nosecone over the disposable barrier sleeve.
 - > The handpiece nosecone should be assembled with minimal effort
 - > If excessive effort is needed for assembly, the barrier sleeve should be inserted further on to the handpiece.

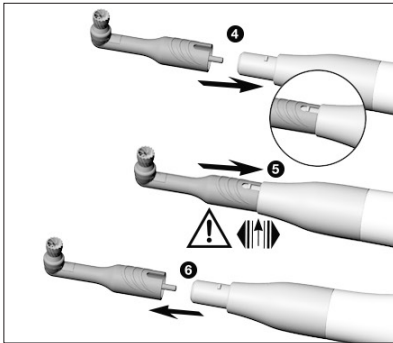

- 4 Align the disposable doriot style prophylaxis angle notch with the raised knob on the handpiece coupling.
- 5 Slide into place.



Check that it is securely in place and completely flushed with the nosecone.

- 6 Remove the doriot style disposable prophylaxis angle after each patient and discard.

13. Operation – Handpiece

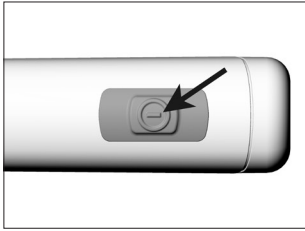

- 1 Press the ON/OFF button on the handpiece.

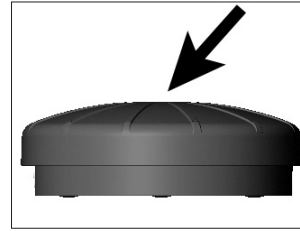

- 2 Press the foot control to activate the handpiece and control the rotation speed of the doriot style disposable prophyl angle.



Press the foot control as far as it will go to attain the maximum speed of 3,000 rpm.



The following flashing signals are shown on the foot control:

Foot control pressed	
Status LED (green) flashes	Foot control is attempting to establish a connection to the paired device
Status LED (green) illuminates	Connection to paired device established

14. Test run



Do not hold the handpiece at eye level!

- > Attach the doriot style disposable prophylaxis angle to the handpiece.
- > Start the handpiece and press the foot control.
- > In the event of malfunctions (e.g. vibrations, unusual noises or overheating), stop the handpiece immediately and contact an authorized Young Dental service partner (see page 43).

15. Hygiene and maintenance – General

 Follow your local and country-specific laws, directives, standards and guidelines for cleaning, reprocessing and sterilization.



- > Wear protective clothing.
- > Switch the handpiece off.
- > Remove the doriot style disposable prophylaxis angle from the handpiece.
- > Pull the nosecone off the handpiece and dispose of the barrier sleeve.
- > Clean and reprocess the handpiece and the foot control **immediately after every treatment!**
- > Sterilize the handpiece nosecone after cleaning and reprocessing.



> The handpiece and foot control are not approved for mechanical cleaning (thermo washer disinfectant) and sterilization.



Do not submerge the medical device into reprocessing agent or an ultrasonic bath!

Part Number	Part Description	Guidance
295721	White Handpiece	Follow reprocessing instructions starting on Page 32 For the handpiece nosecone, follow sterilization instructions on Pages 33-34
295734	Foot Controller	Follow reprocessing instructions starting on Page 32
295786	Stick	Not to be used with contaminated Components. Dispose if contaminated
295788	Charger, including adapter	Follow reprocessing instructions starting on Page 32
295789	Handpiece Cradle	Follow reprocessing instructions starting on Page 32
295830	Disposable Barrier Sleeve	Single Use Only. Dispose after Use

Hygiene and maintenance – General



- > The charger must not be connected.
- > Do not immerse the handpiece and the foot control or clean them under running water.

Warnings

The handpiece cradle, handpiece and foot control are not sterilizable by autoclave, but can be reprocessed following the procedures listed below:

- > The following intermediate level tuberculocidal reprocessing agents are compatible for use on the components listed above:
 - > Dual Quaternary Ammonium surface disinfectant with Alcohol - such as Birex Quat.
- > Do not attempt to reprocess with any other chemicals.

Limitations on Reprocessing

Repeated cleaning has minimum effect on these instruments. End of life is normally determined by wear and damage due to use. Do not use reprocessing agents on sterilizable outer nosecones. Refer to sterilization procedures for sterilizable outer nosecones.

Hygiene and maintenance – Handpiece, Foot Control, Charger/Adapter, and Cradle

Manual cleaning and reprocessing

Point of Use

Remove nosecone and process under guidelines outlined on Page 33.

Remove excess soil with disposable cloth or paper wipe. Discard wipe after use.

Containment and Transportation

Handle with care.

Cleaning

Using a pre-wet wipe or generously spraying on a clean cloth, thoroughly wet the surface of the device, and keep the surfaces wet for 2 minutes. Use additional wipes to ensure 2 minute contact time. Ensure all visible soil is removed. After allowing device to air dry, inspect for any residual soil. Use additional wipes as necessary to remove.

Reprocessing

Using a pre-wet wipe or generously spraying on a clean cloth, thoroughly wet the surface of the device, and keep the device wet for 6 minutes. A second wipe should be used to contact every crack and crevice on the device. Use additional wipes to ensure 6 minute contact time. Allow device to air dry.

Drying

When cleaning, wipe surfaces dry with a clean cloth. Allow surfaces to air dry.



Ensure that no fluids enter the handpiece or foot control.



Do not place the handpiece or foot control into reprocessing solution or an ultrasonic bath!

Hygiene and maintenance – Handpiece Nosecone

Maintenance

Visually inspect to ensure that all contamination has been removed.

Visually inspect power supply and cords for damage. Do NOT add lubricant to the handpiece.

Point of Use

Remove excess soil with a disposable cloth or paper wipe.

Discard wipe after use.

Containment and Transportation

Handle with care.

Manual Cleaning

After every use, clean first with a reprocessing agent listed on Page 31. Use additional wipes as necessary to ensure 2 minute contact time.

> Note the manufacturer's specifications for the use of the reprocessing agent.

Rinse and brush off with demineralized water [$<38^{\circ}\text{C}$ / $<100^{\circ}\text{F}$]

Remove any liquid residues using an absorbent cloth. Use a 2nd cloth to complete a final wipe.

Hygiene and maintenance – Handpiece Nosecone

Sterilization and Storage



After manual cleaning, you must carry out a final sterilization (wrapped) in a Class B or S steam sterilizer (as per EN 13060) in compliance with ANSI AAMI ST55 or ST8.

For both classes, use a minimum sterilization holding time of 3 minutes at 134°C [273°F].

- > Note the manufacturer's specifications on equipment, cleaning agents and detergents.
- > Follow your local and national laws, directives, standards and guidelines.
- > Store sterile goods dust-free and dry



> Please ensure interior and exterior of the handpiece nosecone is completely dry after heat sterilization. Handpiece nosecone may still be hot after cycle is complete.

Maintenance

The standard ISO 14457 stipulates a durability of at least 250 sterilization cycles. In the case of the handpiece nosecone from Young Dental, we recommend you to have regular service carried out after 600 sterilization cycles or one year.



> The reprocessing and sterilization procedures above have been validated to destroy viable microorganisms, but given that the handpiece cannot be sterilized, and that the device is used outside of a sterile field, the device should be considered non-sterile during use.

16. Replacing the O-ring



Do not use sharp tools!

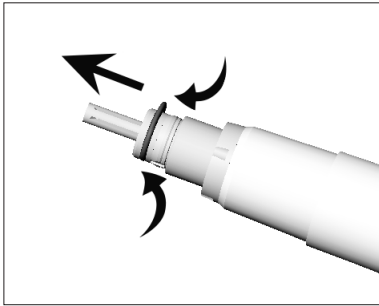

- ① Remove the nosecone from the handpiece.
- ② Hold the O-ring between your thumb and index finger and apply firm pressure to disengage the ring from the metal channel.
- ③ Pull the old O-ring off.
- ④ Replace with a new O-ring.

17. Young Dental Accessories and spare parts



Use only original Young Dental accessories and spare parts or accessories approved by Young Dental.

Supplier: Young Dental partners

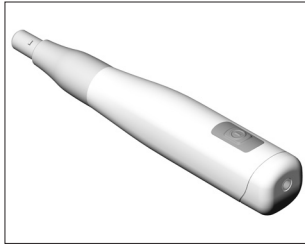

295721

White Handpiece

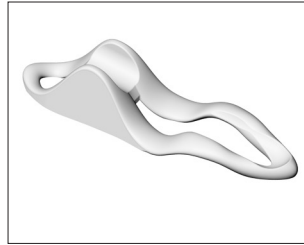

295789

Handpiece cradle

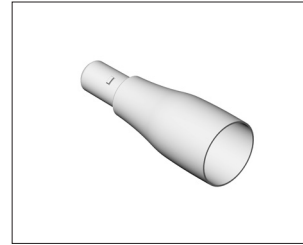

295791

Removable nosecone

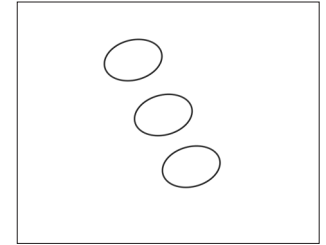

295790

O-ring (3 pcs)

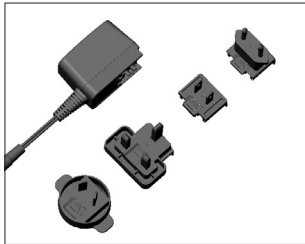

295788

Charger power cord and removable plugs



295792

Foot Controller
incl. Stick

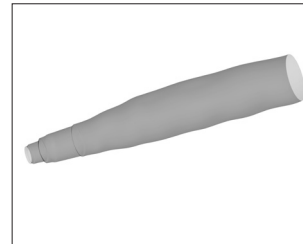

295831

Disposable Barrier Sleeve
(500 pcs)

To maximize performance, please find a wide selection of Young and Vera doriot style disposable prophylaxis angles at Youngdental.com and contact your favorite dealer to purchase.
www.youngdental.com

18. Servicing



Regular checks

Regular servicing of function and safety including the accessories is necessary and should be carried out at least once every three years, unless shorter intervals are prescribed by law. The inspection must be undertaken by a qualified organization and must include the following procedures:

Handpiece

- > External visual inspection
- > Function test

Foot control

- > External visual inspection
- > Function test with check to see if the maximum speed can be reached



The regular inspection must only be performed by an authorized Young Dental service partner (see page 43).



Defective or disused batteries must only be replaced by an authorized Young Dental service partner (see page 43).

Servicing

Repairs and returns

In the case of a fault or malfunction send the complete medical device to an authorized Young Dental service partner (see page 43) for repair. Always return equipment in the original packaging!

19. Technical data

Handpiece	PL-40 H
Battery type:	Li-ion
Rated voltage:	3.7 V
Rated capacity:	680 mAh
Max. speed	3,000 rpm
Max. torque	2 Ncm
Dimensions (WxDxH):	160 x 25 x 28 mm
Weight:	118 g

Foot control	C-NW
Battery type:	Li-ion
Rated voltage:	3.7 V
Rated capacity:	680 mAh
Dimensions (WxDxH):	117 x 117 x 38 mm
Weight:	190 g

Charger	
Rated voltage:	100 – 240 V
Permissible voltage fluctuation:	± 10%
Frequency:	50 – 60 Hz
Power:	6 VA

Technical data

Classification according to Paragraph 6 of the General Specifications for the Safety of Medical Electrical Equipment according to IEC 60601-1/ANSI/AAMI ES 60601-1



Charger power cord: Class II medical electrical equipment

Handpiece: Internally powered



Type BF applied part (not suitable for intracardiac application)



The C-NW foot control is protected against vertically falling drops of water (IPX1 as per IEC 60529)

Pollution level:	2
Overvoltage category:	II
Altitude:	up to 3,000 m above sea level

Temperature information

Temperature of the handpiece at the operator side: max. 55 °C (max. 131 °F)

Temperature of the handpiece at the patient side: max. 50 °C (max. 122 °F)

Ambient conditions

Temperature during storage and transport: -20 °C to +60 °C (-4 °F to +140 °F)

Humidity for storage and transport: 8% to 80% (relative), non-condensing

Temperature in operation: +10 °C to +35 °C (+50 °F to +95 °F)

Humidity in operation: 15% to 80% (relative), non-condensing

18. Disposal



Ensure that the parts are not contaminated on disposal.



Follow your local and national laws, directives, standards and guidelines for disposal.

- > Waste electrical equipment
- > Accessories and spare parts
- > Packaging

Explanation of warranty terms

This medical device has been manufactured with great care by highly qualified specialists. A wide variety of tests and controls guarantee faultless operation. Please note that claims under warranty can only be validated when the directions for use have been followed.

All components, except for the doriot style disposable prophylaxis angle, which is a single use item, are warranted for 1 year from the date of purchase with 1 free battery replacement within the first two years.

Parts will be repaired or replaced at the discretion of Young Dental service provider, provided that the system has been operated and maintained as prescribed in these instructions and has not been subjected to apparent misuse, abuse or accident. Claims covered by this warranty will be honored through your distributor within thirty 30 days from discovery of defect within the applicable warranty period.

We accept no responsibility for damage caused by incorrect handling or by repairs carried out by third parties not authorized to do so by Young Dental!

Claims under warranty – accompanied by proof of purchase – must be sent to the vendor or to an authorized Young Dental service partner. The provision of service under warranty extends neither the warranty period nor any other guarantee period.

Authorized Young Dental service partners

Find your nearest Young Dental service partner at <http://www.youngdental.com>

Simply go to the menu option »Service« for full details.

Alternatively please contact:

W&H Impex Inc., 14300 Henn Rd., Dearborn, MI 48126, USA

t + 1 800 2656277, 1 519 9446739, f + 1 519 9746121, E-Mail: service.us@wh.com

Manufacturer

YOUNG

Young Dental Manufacturing Co.
13705 Shoreline Court East
Earth City, MO 63045 USA

☎ + 1(847)458-5400
customerservice@youngdental.com
www.youngdental.com

Form-Nr. 50938 AEN
Rev. 004 / 22.01.2019
Subject to alterations
295886B